



4x2 HDMI 2.0 Matrix Switcher with Audio Extract/Scale/ARC/EDID

Model No.: LM-MX42-AUDIO



User Manual

Catalog

1. Introduction.....	2
2. Feature.....	2
3. Package Contents.....	3
4. Specifications.....	3
5. Operation Controls and Functions.....	4
5.1 Front Panel.....	4
5.2 Rear Panel.....	5
5.3 IR Remote.....	6
6. Application Example.....	9
7. FAQ.....	1

Thank you for purchasing this product

For optimum performance and safety, please read these instructions carefully before connecting, operating or adjusting this product. Please keep this manual for future reference.

Surge protection device recommended

This product contains sensitive electrical components that may be damaged by electrical spikes, surges, electric shock, lighting strikes, etc. Use of surge protection systems is highly recommended in order to protect and extend the life of your equipment.

1. Introduction

This high performance HDMI Matrix Switcher can switch any of four HDMI sources to two HDMI displays. It supports resolution up to 4K2K@60Hz YCbCr 4:4:4 and HDCP 2.2. It can extract HDMI source device audio to optical and analog L/R output. It supports 4K→1080P downscale function if source is 4K but TV only supports up to 1080P. It also supports ARC and EDID (AUTO/COPY/STD) function. With its 18Gbps bandwidth and the additional features with latest HDMI standards. Flexible control via front panel buttons and IR remote.

2. Feature

- ☆ HDMI 2.0, HDCP 2.2 / HDCP 1.4 and DVI 1.0 compliant
- ☆ Supports 4 HDMI inputs and 2 HDMI outputs
- ☆ Video resolution up to 4K2K@60Hz YCbCr 4:4:4
- ☆ Supports 18Gbps uncompressed bandwidth on all HDMI
- ☆ Supports Dolby Vision, HDR 10+, HLG and CEC function
- ☆ Supports extract HDMI input source device audio of OUT A or OUT B to optical and analog L/R output
- ☆ OUT A and OUT B support 4K to 1080P downscale function
- ☆ Supports ARC (Audio Return Channel) function
- ☆ Supports advanced EDID management including AUTO, COPY and STD
- ☆ Control is via front panel buttons and IR remote

3. Package Contents

- ① 1× 4×2 HDMI2.0 Matrix Switcher
- ② 1× 12V/1A Locking Power Adapter
- ③ 2× Mounting Ears
- ④ 1× IR Remote
- ⑤ 1× User Manual

4. Specifications

Technical	
HDMI Compliance	HDMI 2.0
HDCP Compliance	HDCP 2.2 and HDCP 1.4
Video Bandwidth	18 Gbps
Video Resolution	Up to 4K2K@50/60Hz(YCbCr 4:4:4),4K2K@30Hz.All HDMI 3D TV format, etc.
Color Space	RGB, YCbCr4:4:4, YCbCr4:2:2, YCbCr 4:2:0
Color Depth	8-bit, 10-bit, 12-bit [1080P, 4K30Hz, 4K60Hz (YCbCr 4:2:0)] 8-bit [4K60Hz (YCbCr4:4:4)]
HDMI Audio Formats	PCM2.0/5.1/7.1CH, Dolby Digital/Plus/EX, Dolby True HD, DTS, DTS-EX,DTS-96/24, DTS High Res, DTS-HD Master Audio, DSD
Optical Audio Formats	PCM2.0, Dolby Digital / Plus, DTS
L/R Audio Formats	PCM2.0CH (Note: If ARC function is turned on, the audio port will mute.)
ESD Protection	Human-body Model: ±8kV (Air-gap discharge), ±4kV (Contact discharge)
Connections	

Input Ports	4×HDMI Type A [19-pin female]
Output Ports	2×HDMI Type A [19-pin female] 1×L/R audio out [3.5mm Stereo Mini-jack] 1×OPTICAL audio out [S/PDIF]
Mechanical	
Housing	Metal Enclosure
Color	Black
Dimensions	251mm(W)×105mm(D)×20mm(H)
Weight	620g
Power Supply	Input: AC100~240V 50/60Hz Output: DC12V/1A
Power Consumption	3.8W (max)
Operating Temperature	0°C ~ 40°C / 32°F ~ 104°F
Storage Temperature	-20°C ~ 60°C / -4°F ~ 140°F
Relative Humidity	20~90% RH (non-condensing)

5. Operation Controls and Functions

5.1 Front Panel

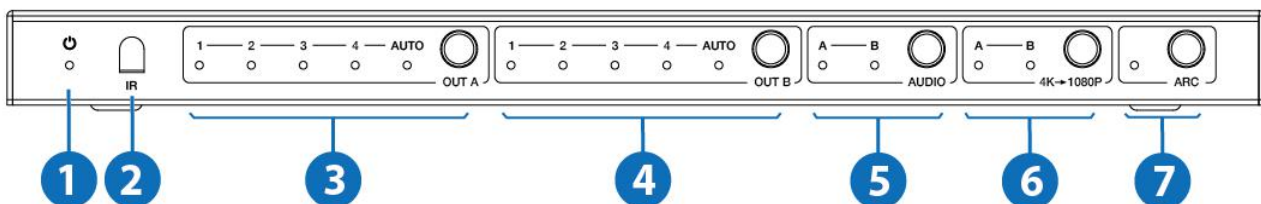

Number	Name	Function description
1	Power LED	The blue LED will illuminate when the product is connected power supply.
2	IR	IR receiver window. It only receives IR remote signal from this product.
3	OUT A button and LED	Press the OUT A button to select an input source to OUT A output, the corresponding blue LED will illuminate.
	AUTO LED	The blue AUTO LED will illuminate and the AUTO function will be turned on when you press the OUT A button up to 3 seconds, press the OUT A button up to 3

		<p>seconds again will turn off the AUTO function.</p> <p>AUTO function: Detect input signal source. The AUTO function is turned on, if an or a few HDMI IN ports are connected source device, OUT A port will output the signal from the last connected input source.</p>
4	OUT B button and LED	Press the OUT B button to select an input source to OUT B output, the corresponding blue LED will illuminate.
	AUTO LED	<p>The blue AUTO LED will illuminate and the AUTO function will be turned on when you press the OUT B button up to 3 seconds, press the OUT B button up to 3 seconds again will turn off the AUTO function.</p> <p>AUTO function: Detect input signal source. The AUTO function is turned on, if an or a few HDMI IN ports are connected source device, OUT B port will output the signal from the last connected input source.</p>
5	AUDIO button	<ul style="list-style-type: none"> ▪ Press AUDIO button to select extract the input source audio from OUT A port or OUT B port to optical and analog L/R output, the corresponding blue LED will illuminate. ▪ If ARC function is turned on, press Audio button to select return the audio signal from OUT A or OUT B display device to optical output, the corresponding blue LED will illuminate. At this time, the analog L/R port is mute.
6	4k→1080P button	Press the button to select OUT A or OUT B 4k→1080P downscale function, the corresponding blue LED will illuminate. For example, if source is 4K but TV only supports 1080P, at this time the input resolution with 4K will downscale to 1080P to TV output.
7	ARC button	Turn on / off ARC function. The ARC LED will illuminate when you turn on the ARC function.

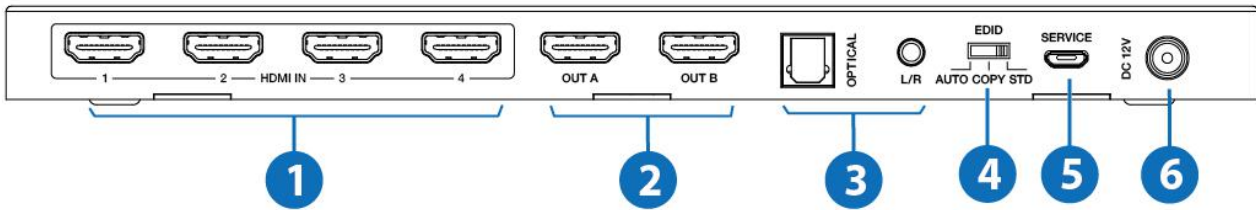

5.2 Rear Panel

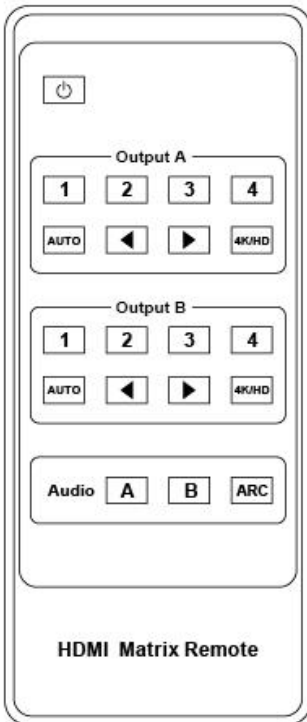

Number	Name	Function description
1	HDMI IN port	HDMI input ports, connect to HDMI source device such as DVD or PS4 with an HDMI cable.
2	HDMI OUT A / OUT B port	HDMI output ports, connect to HDMI display device such as TV or Monitor with an HDMI cable.
3	OPTICAL / L/R port	Connect to audio output device such as amplifier or speaker with optical and analog audio cable.
4	EDID AUTO / COPY / STD	<p>AUTO: Compare with Out A and Out B display device's EDID information, and then sending the best EDID information to source device of Out A and Out B. The source device of Out A and Out B will send the EDID information again to Out A and Out B display device output.</p> <p>COPY: Copy Out A display device's EDID information to source device of Out A and Out B. Then the source device of Out A and Out B will send the EDID information again to Out A and Out B display device output.</p> <p>STD: Out A and Out B display device output default 1080P.</p>
5	SERVICE port	Firmware update port.
6	DC 12V	Plug in 12V/1A adapter to AC wall outlet for power supply.

5.3 IR Remote



	Power on the product or set it to standby mode.
Output A	
1/2/3/4	Select input source signal to Out A port output, the corresponding blue LED on the front panel will illuminate.
	Select the last or next input source signal to OUT A port output, the corresponding blue LED on the front panel will illuminate.
AUTO	Detect input signal source. The Auto function is turned on, if an or a few HDMI IN ports are connected source device, Out A port will output the signal from the last connected input source.
4K/HD	Select Out A 4k→1080P downscale function. For example, if source is 4K but TV only supports

	1080P, at this time the input resolution with 4K will downscale to 1080P to TV output
Output B	
1/2/3/4	Select input source signal to Out B port output, the corresponding blue LED on the front panel will illuminate.
	Select the last or next input source signal to OUT B port output, the corresponding blue LED on the front panel will illuminate.
AUTO	Detect input signal source. The Auto function is turned on, if an or a few HDMI IN ports are connected source device, Out B port will output the signal from the last connected input source.
4K/HD	Select Out B 4k→1080P downscale function. For example, if source is 4K but TV only supports 1080P, at this time the input resolution with 4K will downscale to 1080P to TV output
Audio function	
ARC	Turn on / off ARC function.
Audio A / B	<ul style="list-style-type: none"> ▪ If ARC function is turned on, press Audio A or B button to select return the audio signal from Out A or Out B display device to optical port (TOSLINK) output. At this time, the analog L/R port (Audio out) is mute.

▪ If ARC function is turned off, press Audio A or B button to select extract the input source audio from Out A port or Out B port to optical port (TOSLINK) and analog L/R port (Audio out) output.

6. Application Example

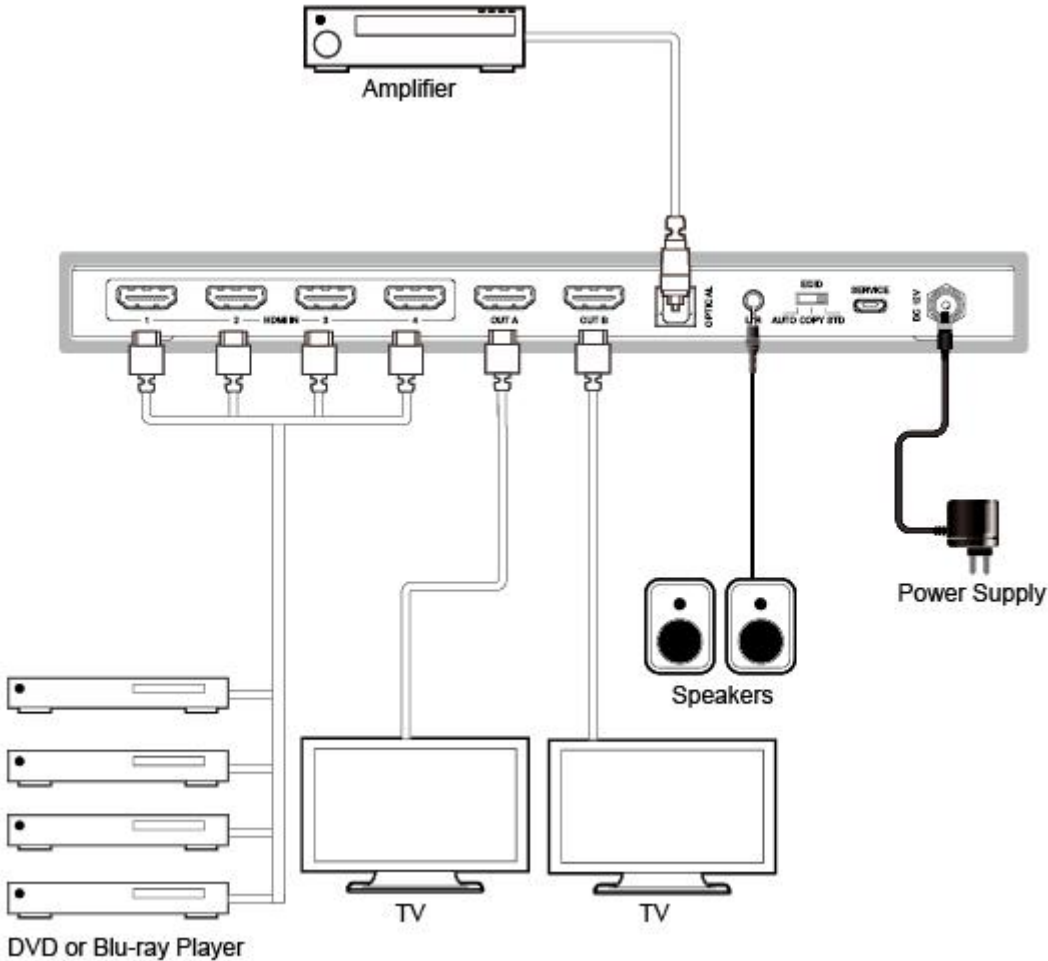

7. FAQ

1. Q: Does this product require an HDMI line length for the connection interface?

A: According to HDMI line length test, HDMI input / output with 4K60Hz YCbCr 4:4:4 is the longest line length up to 8m / 3m.

The use of “Premium High Speed HDMI” cable is highly recommended.

IR remote sends signal distance for 0~7 meters, and angle is plus-minus 45 degrees.

SHENZHEN LINK-MI TECHNOLOGY CO., LTD.

WWW.LINK-MI.COM E-mail: sales@link-mi.com