



HDMI Wireless Extender with one-way IR (100M)

Model No.: LM-WE02



User Manual

VER 1.1

Thank you for purchasing this product

For optimum performance and safety, please read these instructions carefully before connecting, operating or adjusting this product. Please keep this manual for future reference.

Surge protection device recommended

This product contains sensitive electrical components that may be damaged by electrical spikes, surges, electric shock, lightning strikes, etc. Use of surge protection systems is highly recommended in order to protect and extend the life of your equipment.

Table of Contents

1st Introduction.....	1
2nd Feature.....	1
3rd Package Contents.....	2
4th Specification.....	2
5th Operation Controls and Functions.....	3
5.1 Transmitter Panel.....	3
5.2 Receiver Panel.....	4
5.3 Pairing Instruction.....	4
5.4 Updating Instruction.....	5
5.5 IR Pin Definition.....	5
6th Application.....	7

1st Introduction

This product is based on H.265 standard solution for distribution one HD source to one HD display. It extends distance up to 330ft/100 meters between transmitter and receiver via wireless transmission (An open environment without Wi-Fi interference), and supports one-way IR control simultaneously. It offers high quality configurable, low-bandwidth H.265 compression video and supports resolution up to 1080P@60Hz. This wireless extender is designed special to transmit high definition video & audio within one room.

This wireless extender offers the most convenient solution for HDMI extension with long distance capability and doesn't need to connect CAT cable to transmission. It is the perfect solution for any application.

2nd Feature

- HDMI 1.3, HDCP 1.4 and DVI 1.0 compliant
- Supports one HDMI HD source to one HDMI HD display via wireless transmission
- With one-way IR control
- Video resolution up to 1080P@60Hz
- Transmission distance: One-to-one connects transmission distance up to 330ft/100m. (An open environment without Wi-Fi interference.)
- Audio format supports PCM 2.0CH 32KHz/44.1KHz/48KHz
- H.265 high performance code supported, adopting high bit rate mode

- End-to-end delays under 150Ms
- Compact design for easy and flexible installation.

3rd Package Contents

Qty	Item
1	HDMI Wireless Extender (Transmitter)
1	HDMI Wireless Extender (Receiver)
1	IR Blaster cable (1.5 meters)
1	20~60KHz IR Receiver cable (1.5 meters)
4	5G WiFi Antennas
2	5V/1A Power Adapters
1	User Manual

4th Specification

Technical	
HDMI Compliance	HDMI 1.3
HDCP Compliance	HDCP 1.4
Video Bandwidth	6.75Gbps
Video Resolution	1080p, 1080i, 720p, 720i, 480p, 480i, the maximum up to 1920×1080@60Hz The PC resolution is up to 1920×1200@60Hz
Color Space	RGB/YCbCr 4:4:4, YCbCr 4:2:2, YUV 4:2:0
Color Depth	8/10/12-bit
HDMI Audio Formats	PCM 2.0CH 32KHz/44.1KHz/48KHz
ESD Protection	Human body model — ±8kV (Air-gap discharge) & ±4kV (Contact discharge)
Connections	
Transmitter	Inputs: 1x HDMI Type A [19-pin female] 1x SERVICE [Micro USB, Update port] Outputs: 1x IR OUT [3.5mm Stereo Mini-jack] 2x WiFi OUT [WiFi antenna]
Receiver	Inputs: 1x IR IN [3.5mm Stereo Mini-jack]

	2x WiFi IN [WiFi antenna] 1x SERVICE [Micro USB, Update port] Outputs: 1x HDMI Type A [19-pin female]
Mechanical	
Housing	Plastic Enclosure
Color	Black
Dimensions	Transmitter / Receiver: 76mm [W] x 98mm [D] x 21mm [H]
Weight	Transmitter / Receiver: 100g
Power Supply	Input: AC100 - 240V 50/60Hz Output: DC 5V/1A
Power Consumption	Transmitter : 2.25W, Receiver: 1.8W
Operating Temperature	32 - 104° F / 0 - 40° C
Storage Temperature	-4 - 140° F / -20 - 60° C
Relative Humidity	20 - 90% RH (no condensation)
Resolution / Cable Length	1080P60Hz -Feet / Meters
HDMI IN / OUT	42ft / 15M
The use of 'Premium High Speed HDMI' cable is highly recommended.	

5th Operation Controls and Functions

5.1 Transmitter Panel

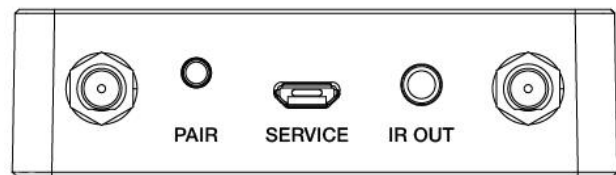
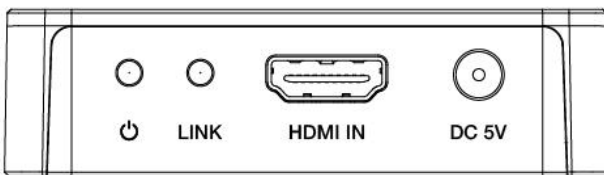

Name	Function description
Power LED	Red LED indicates that the encoder is powered.
LINK LED (Green)	<ul style="list-style-type: none"> ■ Illuminate: Pair success. ■ Flicker quickly: The encoder is pairing. ■ Flicker slowly: The encoder and decoder are transmitting video signal. ■ Off: No pair or paired success but no signal transmission.
HDMI IN	HDMI source input.
DC 5V	DC 5V for 5V 1A power adapter.

Antenna port	Connect to WiFi antenna.
PAIR button	<ul style="list-style-type: none"> ■ Press quickly the button will reset the encoder to factory default status. ■ Press the button simultaneously both encoder and decoder for 3 seconds will pair.
SERVICE port	Firmware update port.
IR OUT	IR port output for control of the source device.
Antenna port	Connect to WiFi antenna.

5.2 Receiver Panel

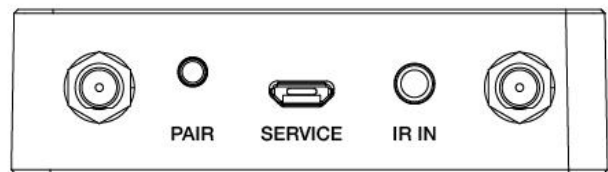
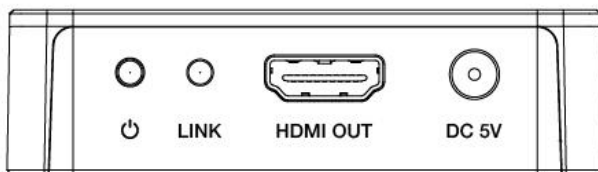

Name	Function description
Power LED	Red LED indicates that the decoder is powered.
LINK LED (Green)	<ul style="list-style-type: none"> ■ Illuminate: Pair success. ■ Flicker quickly: The decoder is pairing. ■ Flicker slowly: The encoder and decoder are transmitting video signal. ■ Off: No pair or paired success but no signal transmission.
HDMI OUT	HDMI output for display.
DC 5V	DC 5V for 5V 1A power adapter.
Antenna port	Connect to WiFi antenna.
PAIR button	<ul style="list-style-type: none"> ■ Press quickly the button will copy the EDID of display device to source device. ■ Press the button simultaneously both encoder and decoder for 3 seconds will pair.
SERVICE port	Firmware update port.
IR IN	IR port input to receiving the signal of IR remote.
Antenna port	Connect to WiFi antenna.

5.3 Pairing Instruction

Power on the transmitter and receiver then press simultaneously the **PAIR** button for three seconds, and the **LINK LEDs** will flicker quickly. If the LINK

LEDs change from flicker quickly to indicate that means pair success. Then let go of your hands and the LINK LEDs are off. When the encoder and decoder have signal transmission then the LINK LEDs will flicker slowly.

LINK LED status (Green)	Description
Flicker quickly	Establish pairing.
Illuminate	Paired success.
Off	No pair or paired success but no signal transmission.
Flicker slowly	Transmitting video signal.

5.4 Updating Instruction

The update file need to change the name for **update.bin** then put in the **root directory** of U disk. The unit is power off status and inserts the U disk to SERVICE port. Hold down the **PAIR** button and power on the unit simultaneously. The **LINK LED** indicates when the unit is updating then let go of your hand. If the update has finished, the LINK LED will automatically off.

5.5 IR Pin Definition

IR Receiver and Blaster pin's definition as below:



IR RECEIVER



IR BLASTER

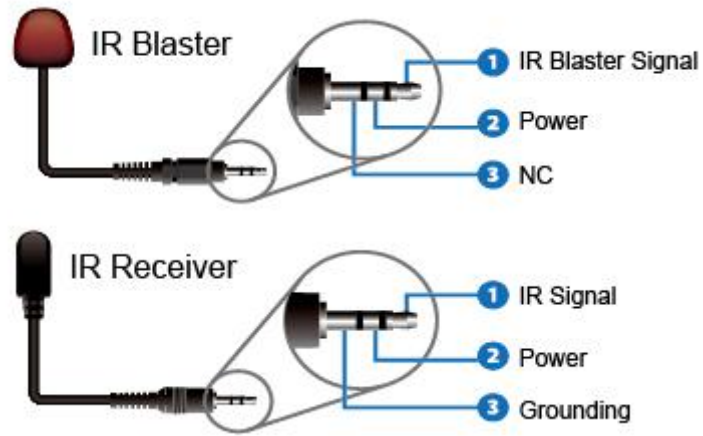

The following is IR system diagram about IR cable use method.

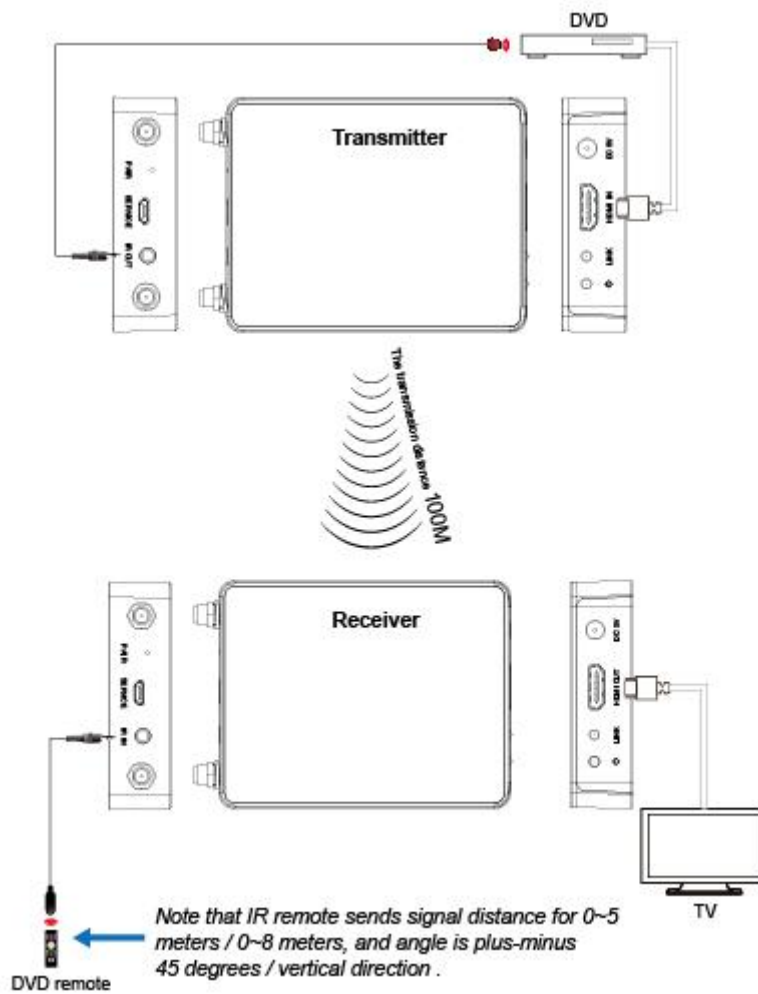

6th Application

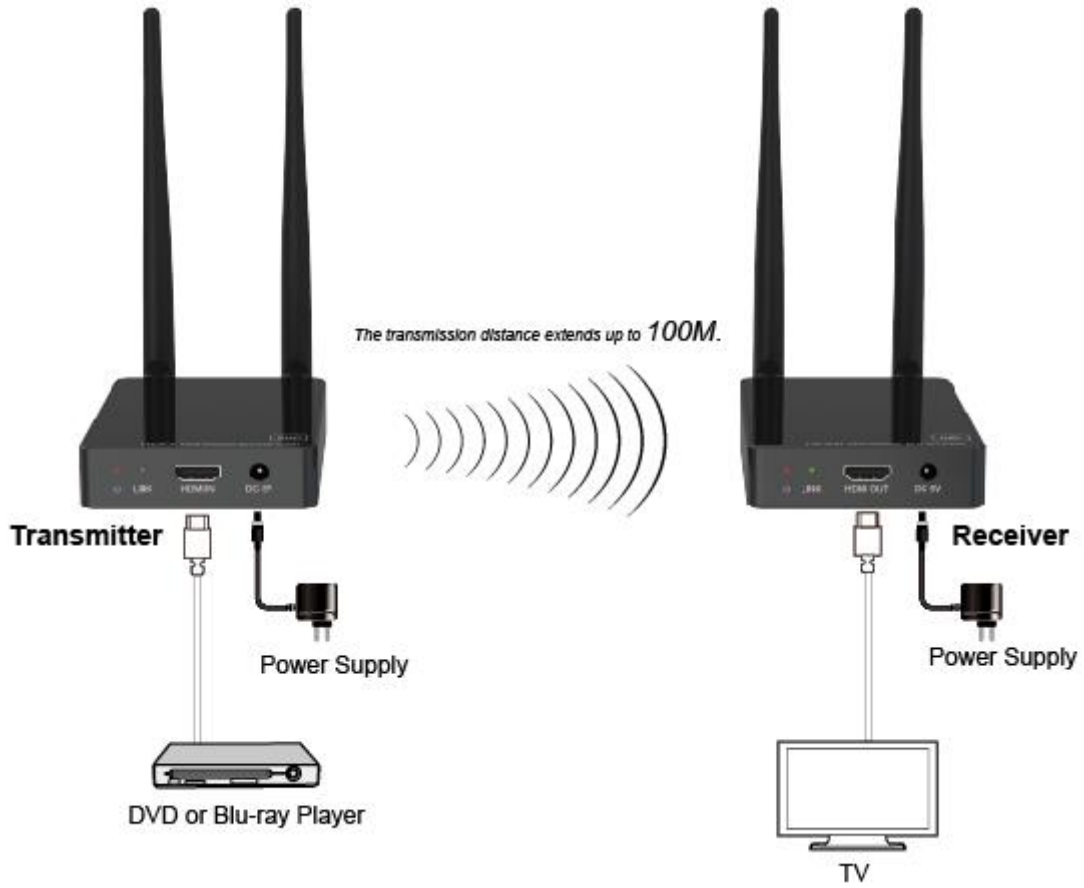

SHENZHEN LINK-MI TECHNOLOGY CO., LTD.

WWW.LINK-MI.COM E-mail: sales@link-mi.com